

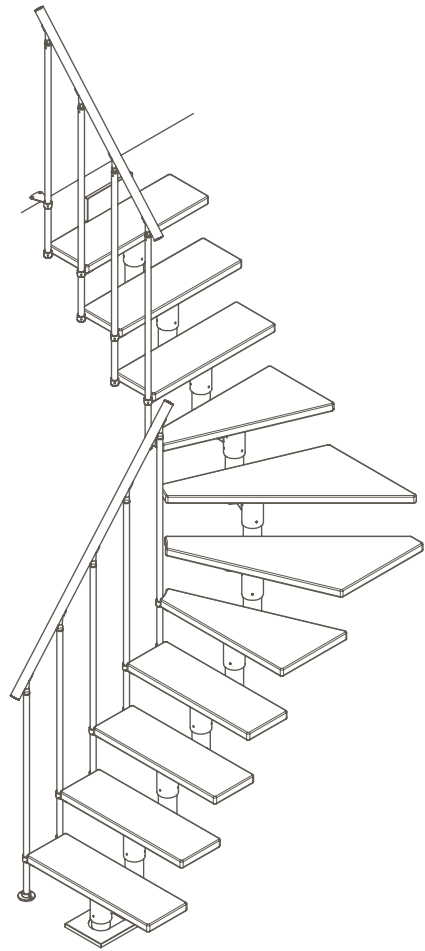

# CORK

## DIMENSION

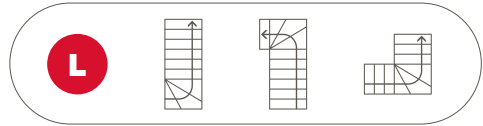
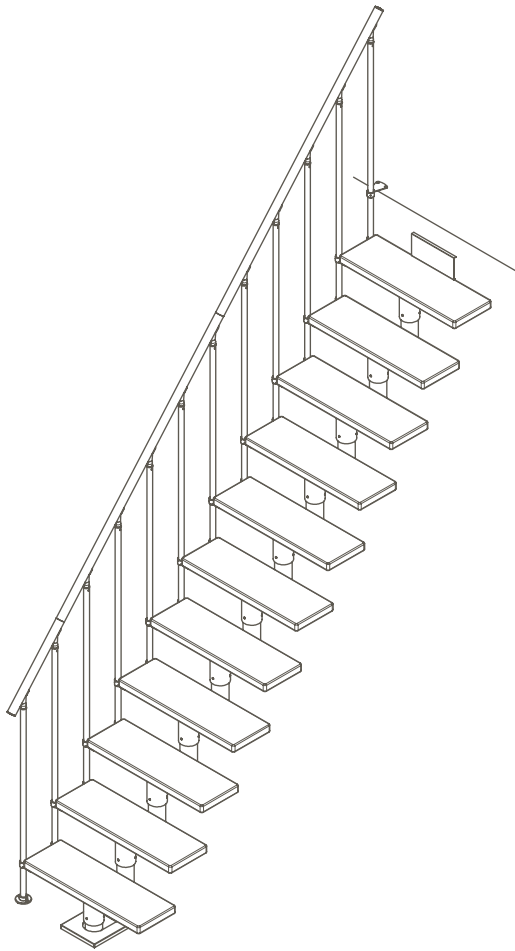
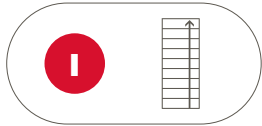

 Video: [www.dolle.com/cork](http://www.dolle.com/cork)

NO. OF TREADS	PAGE
11 treads . . . . .	7
12 treads . . . . .	9
13 treads . . . . .	11
14 treads . . . . .	15
15 treads . . . . .	19

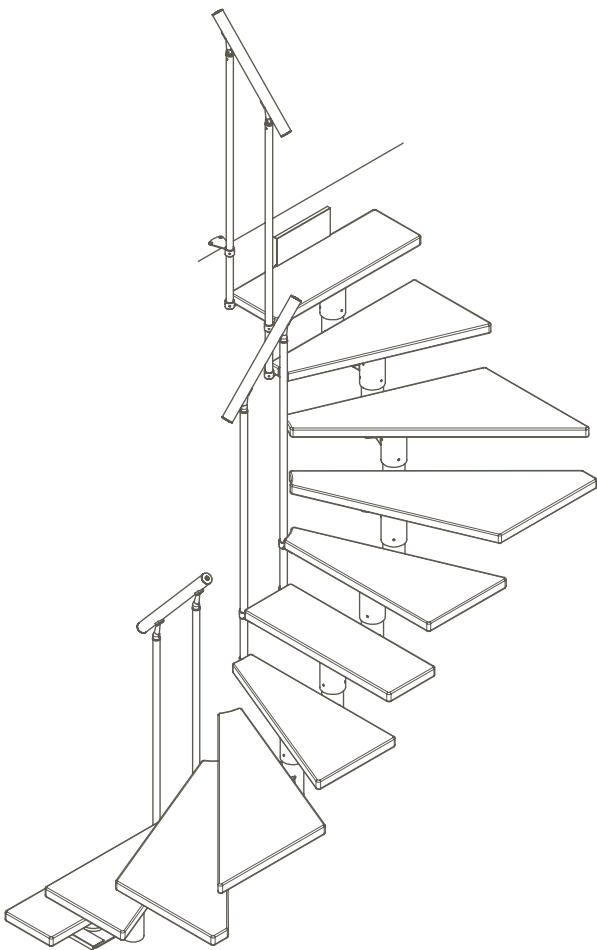
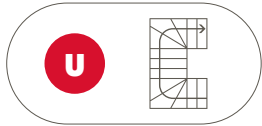

 Video: [www.dolle.com/cork](http://www.dolle.com/cork)

NO. OF TREADS	PAGE
11 treads . . . . .	7
12 treads . . . . .	9
13 treads . . . . .	11
14 treads . . . . .	15
15 treads . . . . .	19

# STAIRCASE TERMINOLOGY











**C1**
**E**
**G**
**H**

	C1	E	G	H
	Staircase width w. 1 banister	Headroom	Going (of tread)	Height floor-to-floor
	Szerokość schodów z jedną balustradą	Wysokość nad schodami	Głębokość stopnia	Wysokość kondygnacji od podłogi do podłogi
	Šířka schodiště s 1 zábradlím	Výška nad schodištěm	Hloubka nášlapu	Výška patra podlaha-podlaha
	Ширина лестницы, одно перила	Минимальная высота потолка над лестницей	Глубина ступени	Высота от пола до пола
	Laiptų su viena balustrada plotis	Aukštis virš laiptų	Pakopos gylis	Aukšto aukštis
	Kápru ar margām vienā pusē platums	Augstums virs kāpnēm	Pakāpiena dziļums	Stāva augstums
	Úhe kásiupuuga trepi laius	Körgus trepi kohal	Astme sügavus	Korruse kõrgus
	Širina stopnic z eno ograjo	Višina nad stopnicami	Hodalna globina stopnice	Višina nadstropja
	Širina stepenica s jednom ogradom	Visina iznad stepenica	Dubina stuba	Visina kata
	Šírka schodov s jedným zábradlím	Výška nad schodmi	Hĺbka stupňa	Výška podlažia

**M**
**N**
**O**
**P**

	M	N	O	P
	Opening size length	Opening size width	Clear width	Pitch
	Długość otworu montażowego	Szerokość otworu montażowego	Szerokość schodów bez balustrady	Kąt nachylenia schodów
	Délka stavebního otvoru	Šířka stavebního otvoru	Čistá šířka bez zábradlí	Sklon schodiště
	Проем монтажа - длина	Проем монтажа - ширина	Ширина лестницы без перил	Угол наклона лестницы
	Montavimo angos ilgis	Montavimo angos plotis	Laiptų be balustrados plotis	Laiptų pasvirimo kampas
	Montážas atveres garums	Montážas atveres platums	Kápru bez margām platums	Kápru slīpuma leņķis
	Montaažiava pikkus	Montaažiava laius	Ilma kásiupuuta trepi laius	Trepi kaldenurk
	Dolžina pritrđilne luknje	Širina montažne luknje	Širina stopnic brez ograje	Kot nagiba stopnic
	Duljina montažne rupe	Širina montažne rupe	Širina stepenica bez ograde	Kut nagiba stepenica
	Dĺžka montážneho otvoru	Šírka montážneho otvoru	Šírka schodov bez zábradlia	Uhol sklonu schodov

**R**
**R1**
**S**
**T**

	R	R1	S	T
	Total going length	Total going width	Rise height	Number of treads
	Zabieg schodów- długość	Zabieg schodów- szerokość	Wysokość stopnia	Ilość stopni
	Celková pochozí délka	Celková pochozí šířka	Výška schodu	Počet nášlapů
	Забегная часть лестницы - длина	Забегная часть лестницы - ширина	Шаг ступени	Кол-во ступеней
	Laiptų posūkis - ilgis	Laiptų posūkis - plotis	Pakopos aukštis	Pakopų kiekis
	Kápru pagrieziens — garums	Kápru pagrieziens - platums	Pakāpiena augstums	Pakāpienu skaits
	Trepimarss- pikkus	Trepimarss - laius	Astme kõrgus	Astmete arv
	Širina 1 prostora stopnišča	Širina 2 prostora stopnišča	Višina stopnice	Število stopnic
	Zavoj stepenica- duljina	Zavoj stepenica- širina	Visina stepenice	Broj stepenica
	Rameno – dĺžka	Rameno – šírka	Výška stupňa	Počet stupňov

**V**
**W**
**X**
**Z**

	V	W	X	Z
	Tread depth	Tread width	Tread thickness	Deck thickness
	Głębokość stopnia	Szerokość stopnia	Grubość stopnia	Grubość stropu
	Hloubka nášlapu	Šířka nášlapu	Tloušťka nášlapu	Tloušťka stropu
	Глубина ступени	Ширина ступени	Толщина ступени	Толщина плиты
	Pakopos gylis	Pakopos plotis	Pakopos storumas	Lubų storumas
	Pakāpiena dziļums	Pakāpiena platums	Pakāpiena biezums	Griestu biezums
	Astme sügavus	Astme laius	Astme jāmedus	Tala jāmedus
	Globina stopnice	Širina stopnice	Debelina stopnice	Debelina stropa
	Dubina stuba	Širina stuba	Debljina stuba	Debljina stropa
	Hĺbka stupňa	Šírka stupňa	Hrúbka stupňa	Hrúbka stropu

# DIMENSIONS

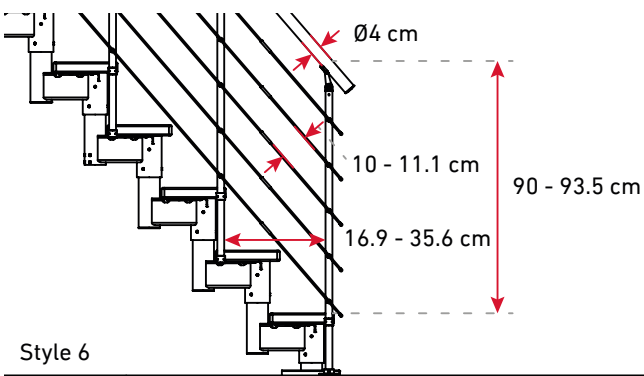
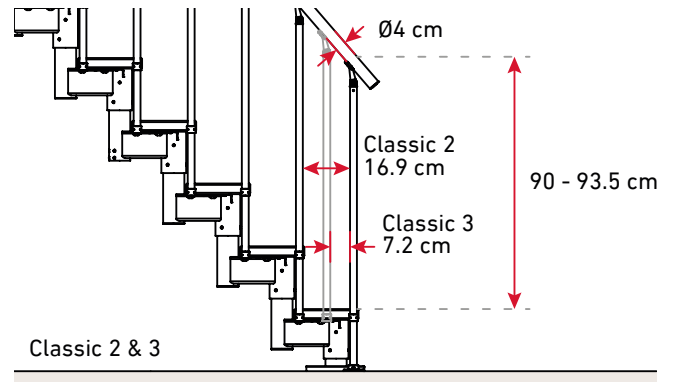
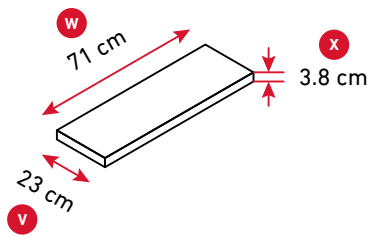
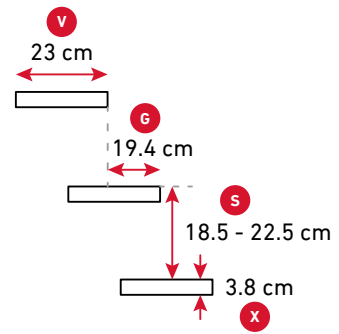
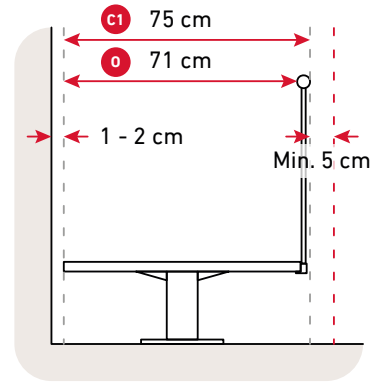
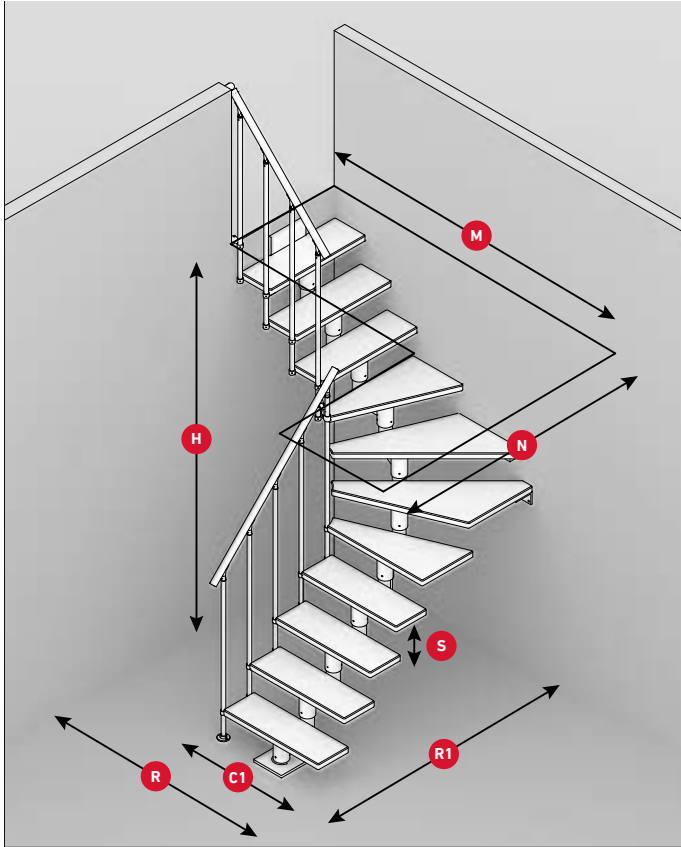

# DIMENSIONS

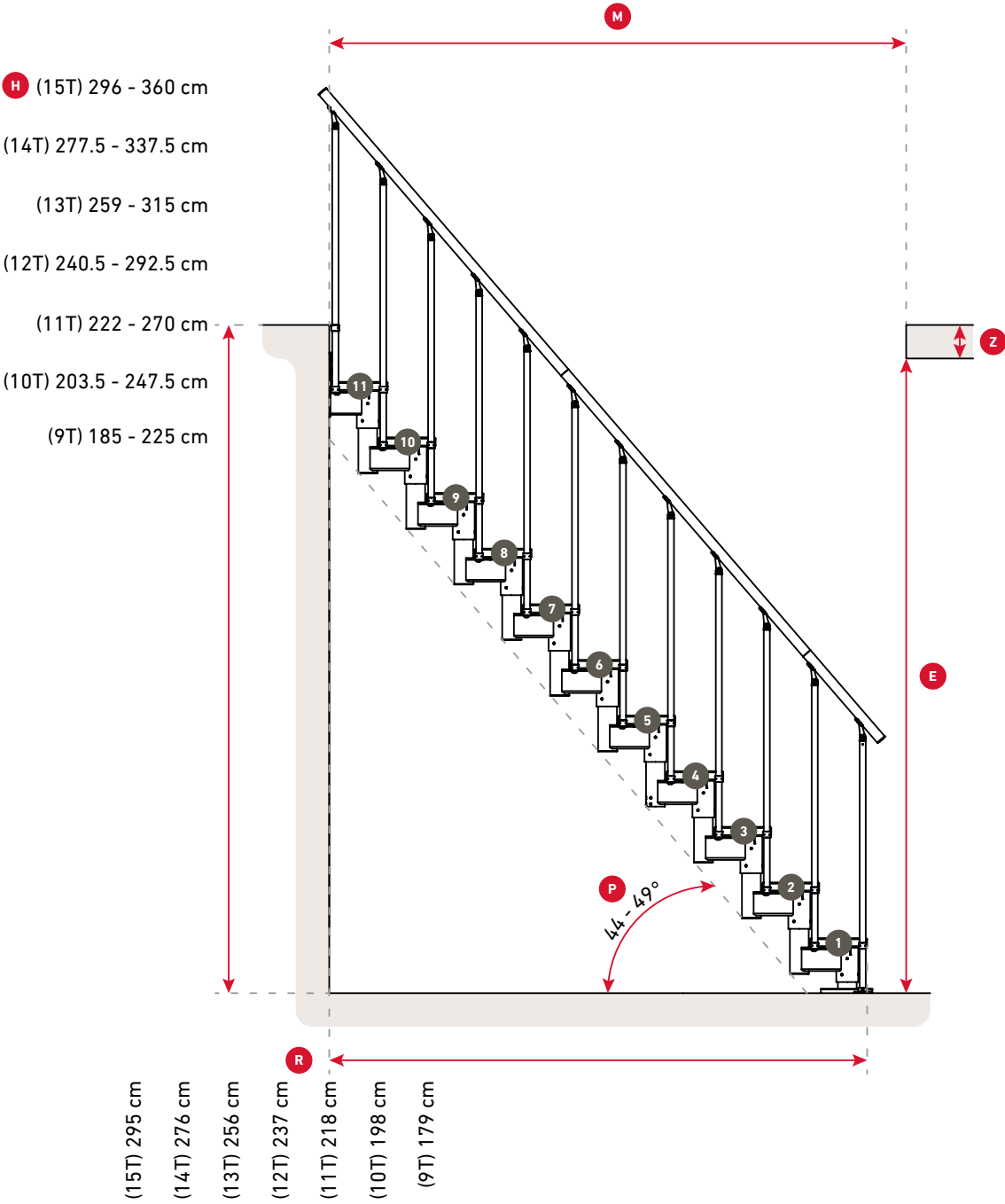

# CORK 11 TREADS

**H** 222 - 270 cm — Staircase dimensions incl. handrail on 1 side

--- Floor opening size is defined based on 2 cm space to wall, 5 cm space for hand, 19 cm rise height, 25 cm deck thickness, 200 cm headspace.

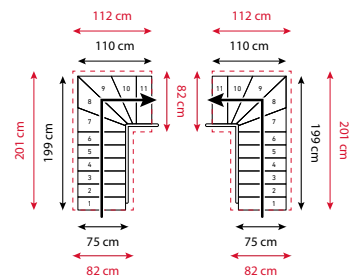
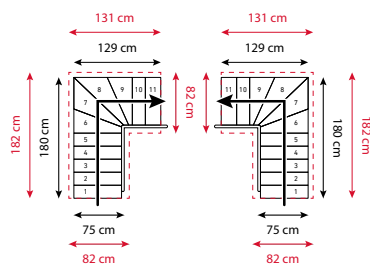
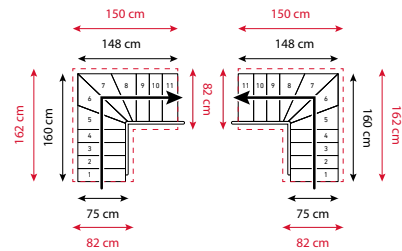
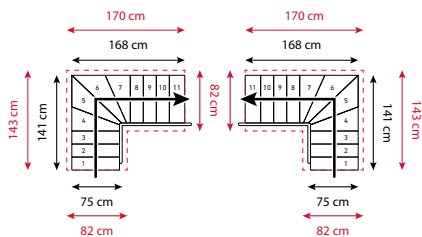
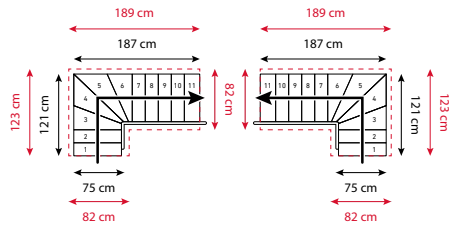
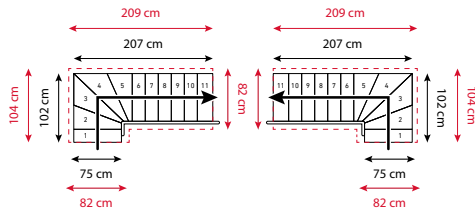
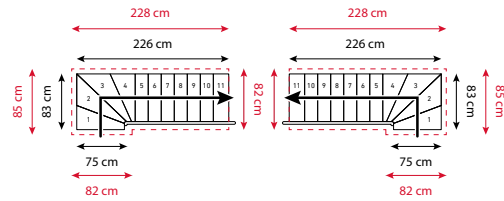
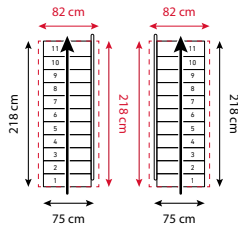

# CORK 11 TREADS

**H** 222 - 270 cm — Staircase dimensions incl. handrail on 1 side

--- Floor opening size is defined based on 2 cm space to wall, 5 cm space for hand, 19 cm rise height, 25 cm deck thickness, 200 cm headspace.

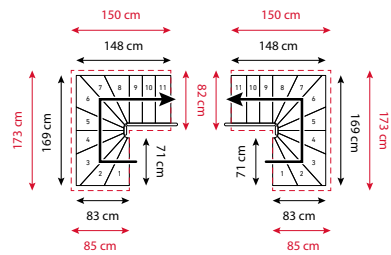
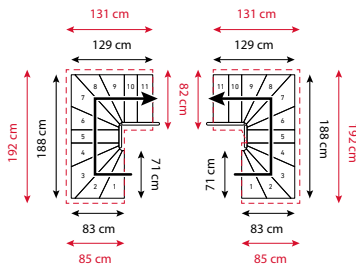
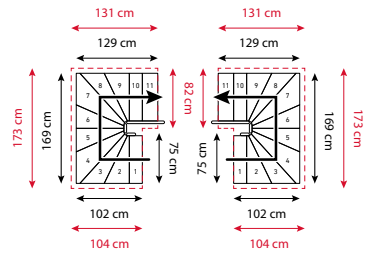
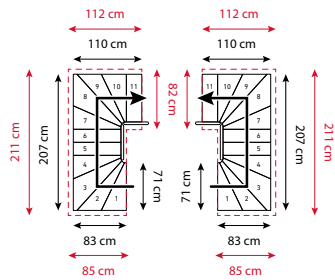
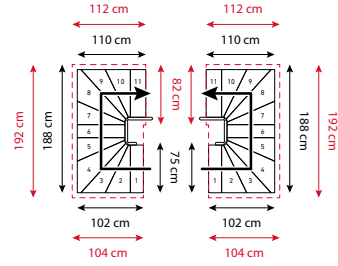
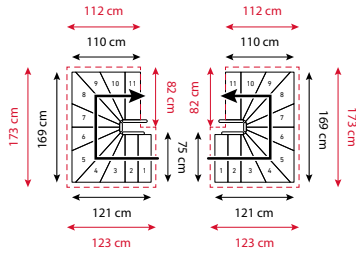



# CORK 12 TREADS

**H** 240.5 - 292.5 cm

— Staircase dimensions incl. handrail on 1 side

- - Floor opening size is defined based on 2 cm space to wall, 5 cm space for hand, 19 cm rise height, 25 cm deck thickness, 200 cm headspace.

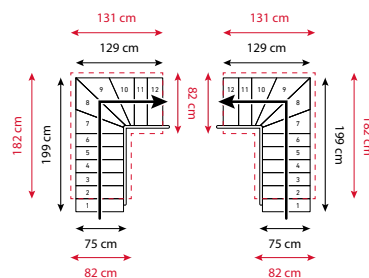
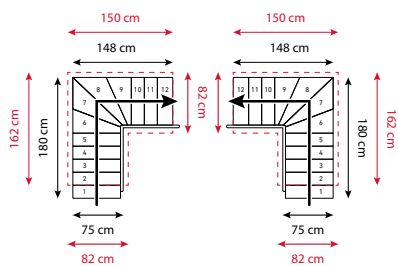
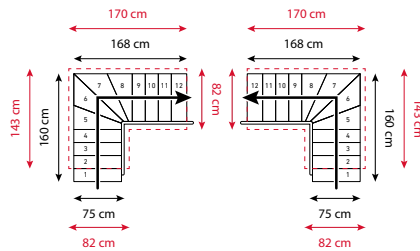
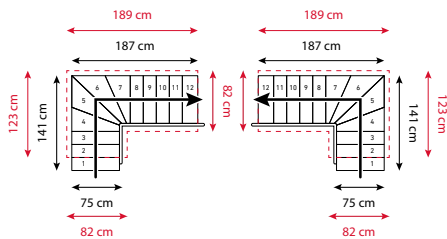
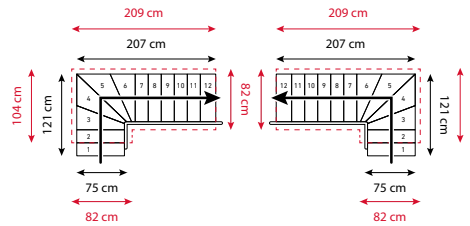
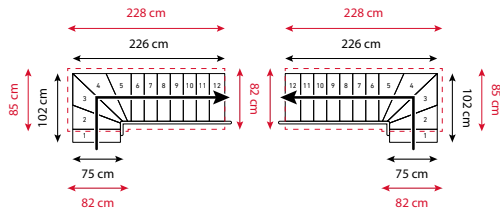
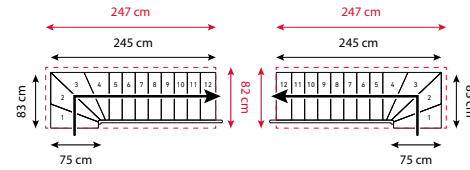
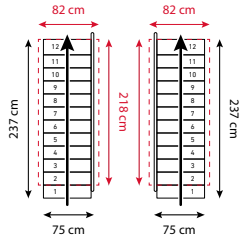

# CORK 12 TREADS

H 240.5 - 292.5 cm

— Staircase dimensions incl. handrail on 1 side

- - Floor opening size is defined based on 2 cm space to wall, 5 cm space for hand, 19 cm rise height, 25 cm deck thickness, 200 cm headspace.

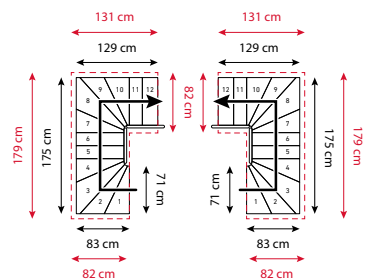
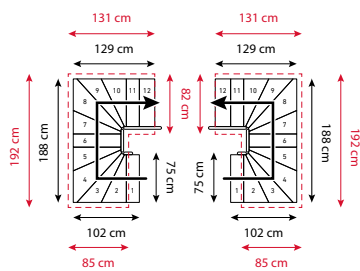
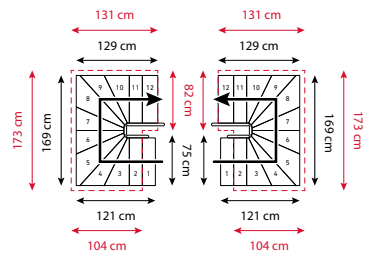
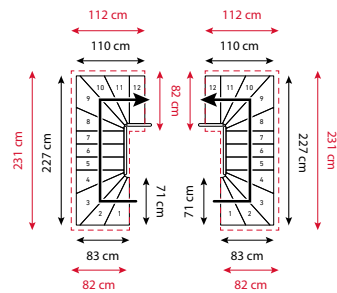
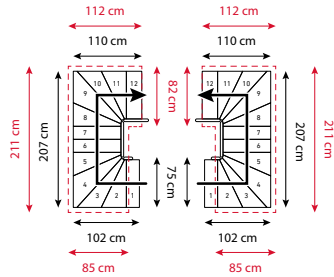
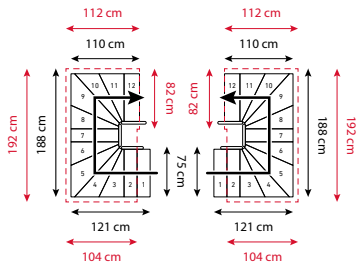
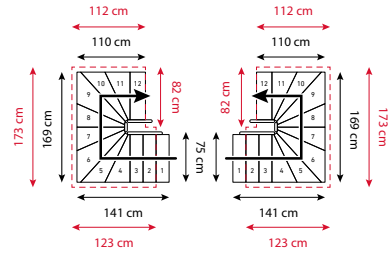
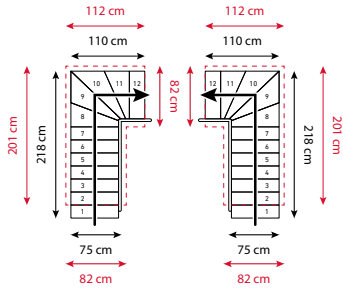

# CORK 12 TREADS

**H** 240.5 - 292.5 cm — Staircase dimensions incl. handrail on 1 side

--- Floor opening size is defined based on 2 cm space to wall, 5 cm space for hand, 19 cm rise height, 25 cm deck thickness, 200 cm headspace.

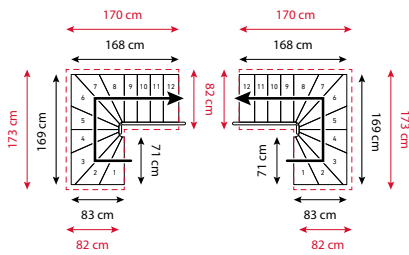
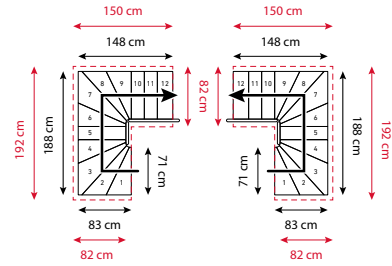
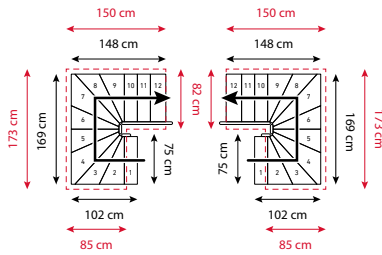

# CORK 13 TREADS

**H** 259 - 315 cm — Staircase dimensions incl. handrail on 1 side

--- Floor opening size is defined based on 2 cm space to wall, 5 cm space for hand, 19 cm rise height, 25 cm deck thickness, 200 cm headspace.

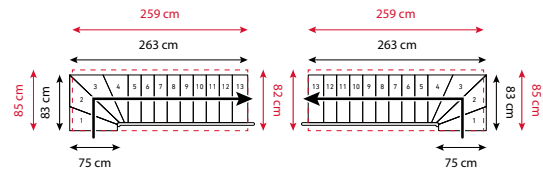
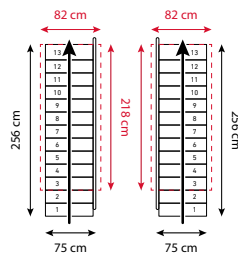

# CORK 13 TREADS

H 259 - 315 cm

— Staircase dimensions incl. handrail on 1 side

- - Floor opening size is defined based on 2 cm space to wall, 5 cm space for hand, 19 cm rise height, 25 cm deck thickness, 200 cm headspace.

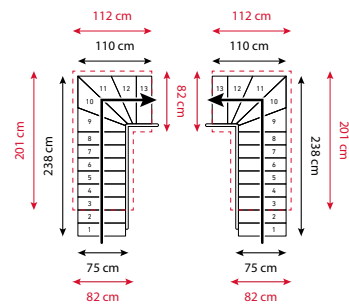
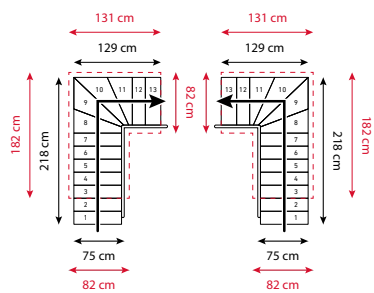
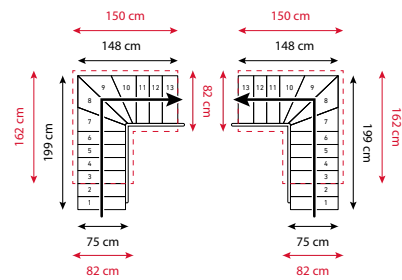
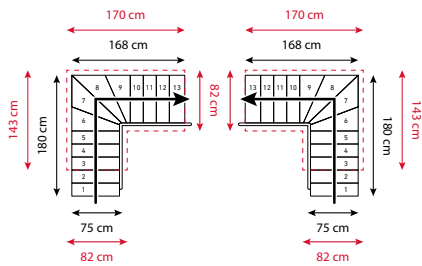
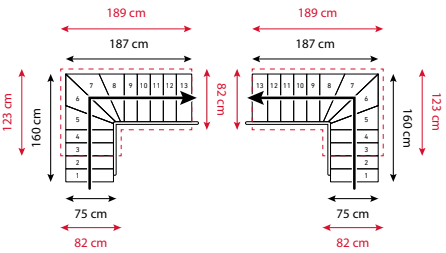
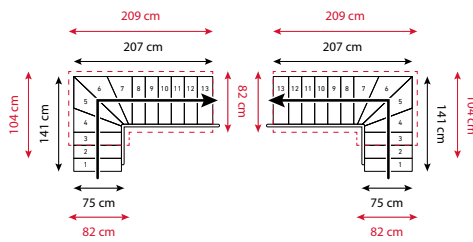
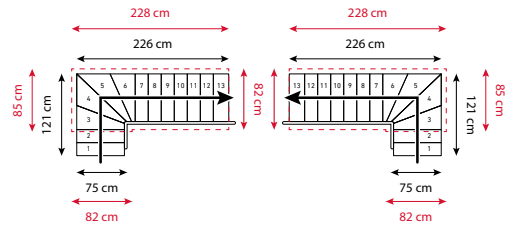
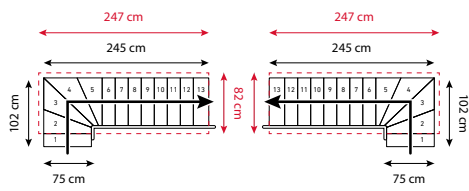

# CORK 13 TREADS

**H** 259 - 315 cm — Staircase dimensions incl. handrail on 1 side

--- Floor opening size is defined based on 2 cm space to wall, 5 cm space for hand, 19 cm rise height, 25 cm deck thickness, 200 cm headspace.

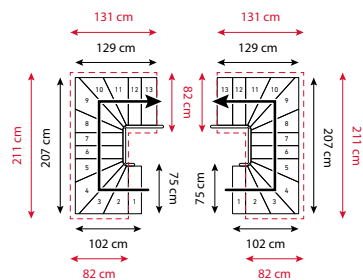
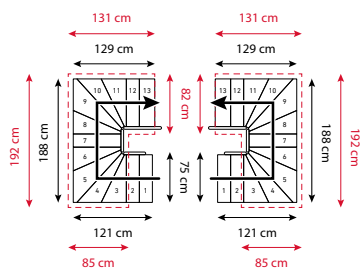
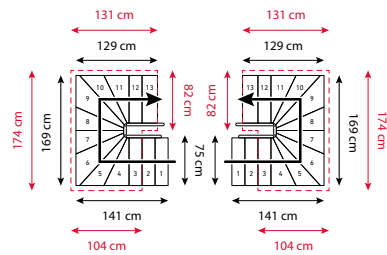
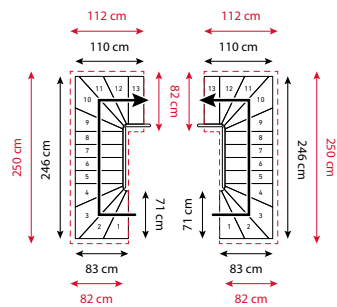
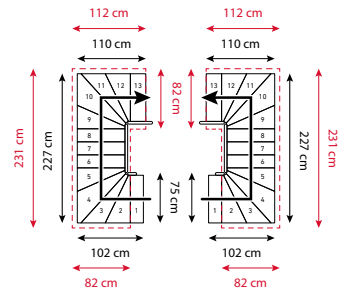
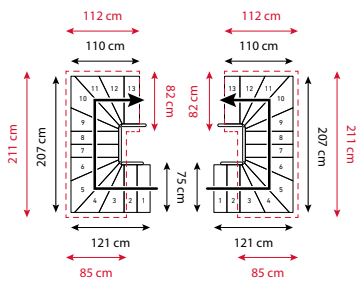
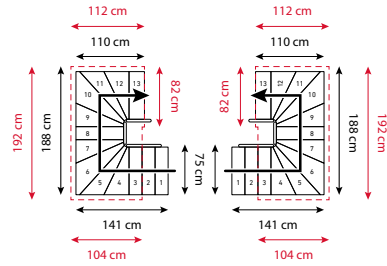
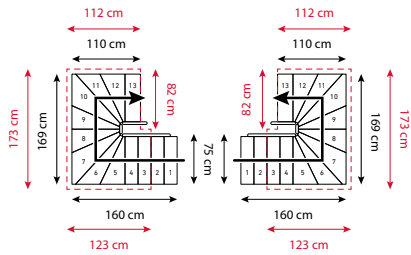

# CORK 13 TREADS

H 259 - 315 cm

— Staircase dimensions incl. handrail on 1 side

- - - Floor opening size is defined based on 2 cm space to wall, 5 cm space for hand, 19 cm rise height, 25 cm deck thickness, 200 cm headspace.

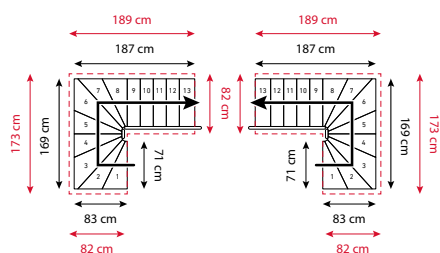
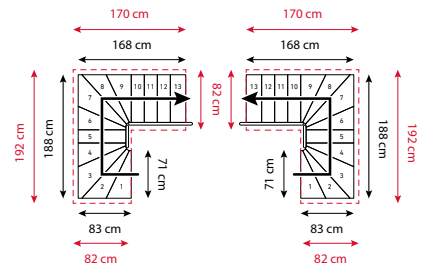
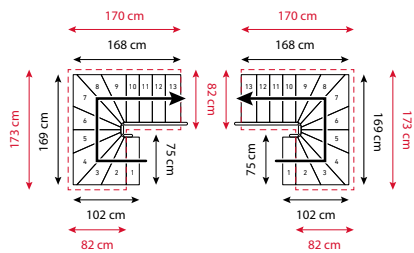
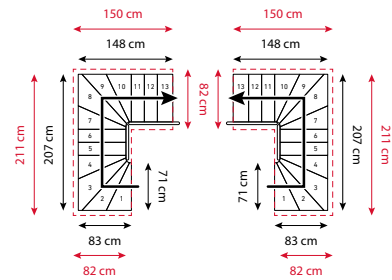
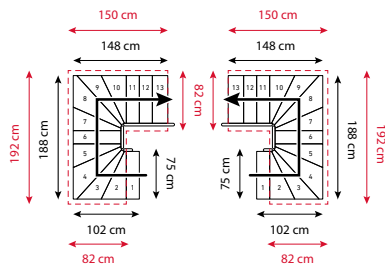
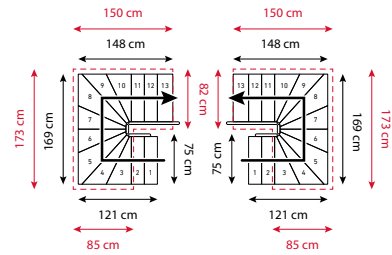
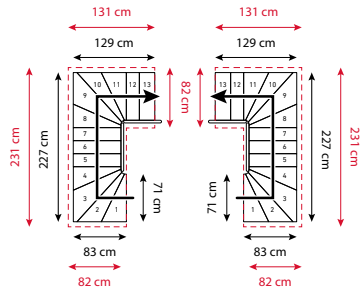

# CORK 14 TREADS

H 277.5 - 337.5 cm

— Staircase dimensions incl. handrail on 1 side

- - - Floor opening size is defined based on 2 cm space to wall, 5 cm space for hand, 19 cm rise height, 25 cm deck thickness, 200 cm headspace.

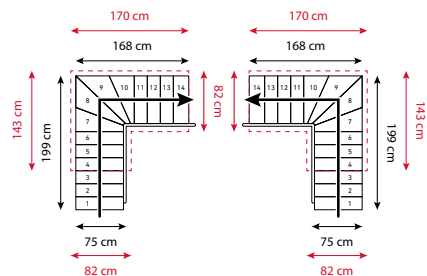
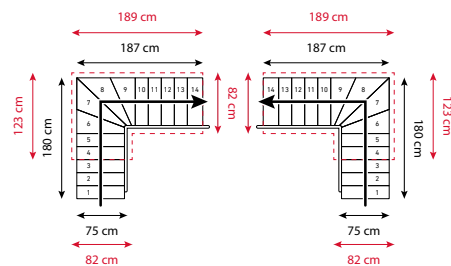
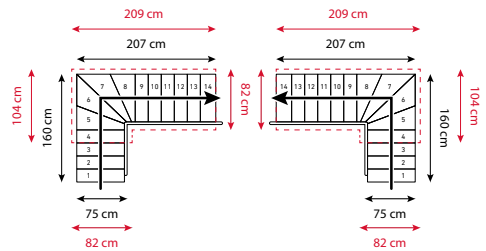
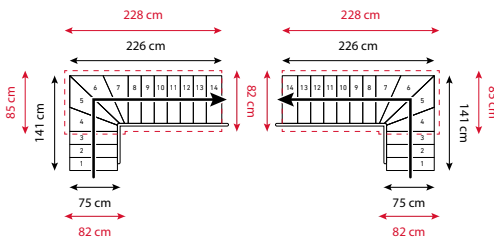
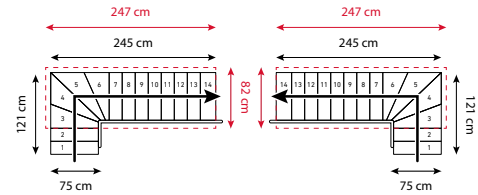
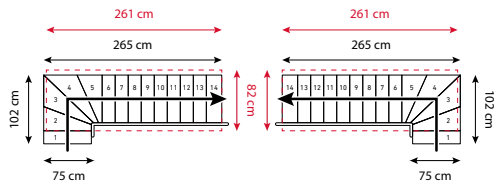
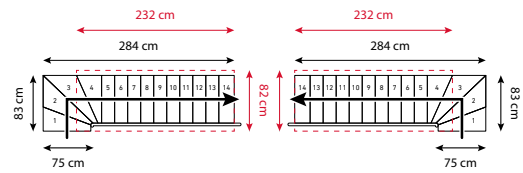
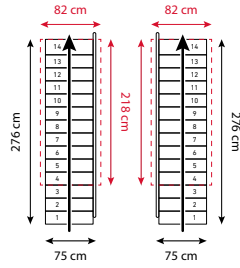

# CORK 14 TREADS

H 277.5 - 337.5 cm

— Staircase dimensions incl. handrail on 1 side

- - Floor opening size is defined based on 2 cm space to wall, 5 cm space for hand, 19 cm rise height, 25 cm deck thickness, 200 cm headspace.

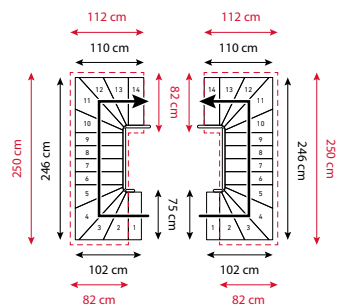
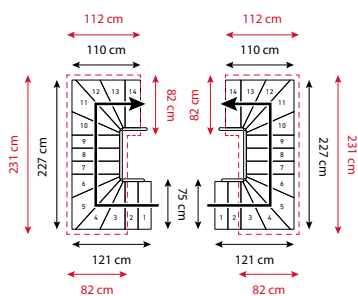
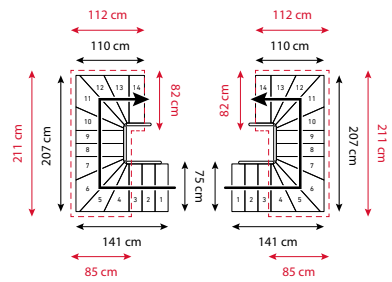
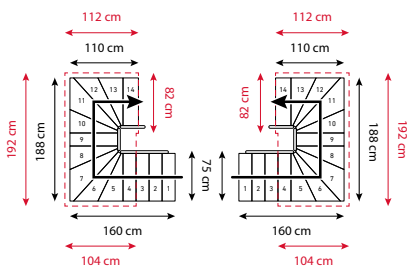
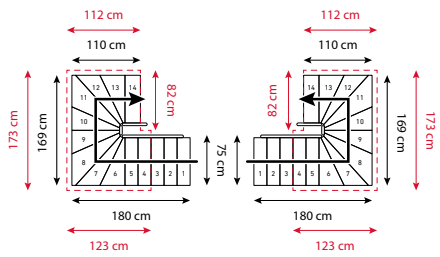
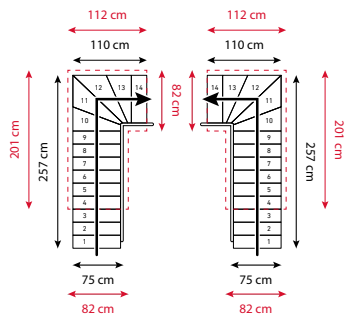
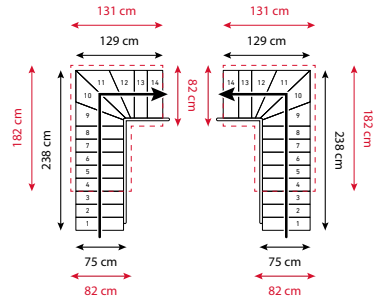
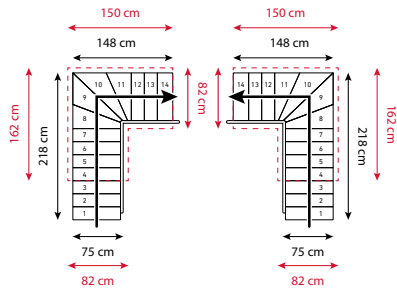



# CORK 14 TREADS

H 277.5 - 337.5 cm

— Staircase dimensions incl. handrail on 1 side

- - Floor opening size is defined based on 2 cm space to wall, 5 cm space for hand, 19 cm rise height, 25 cm deck thickness, 200 cm headspace.

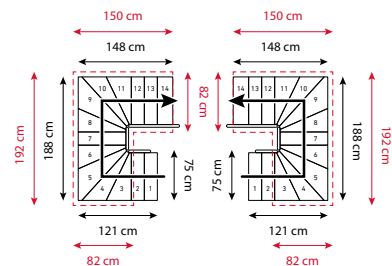
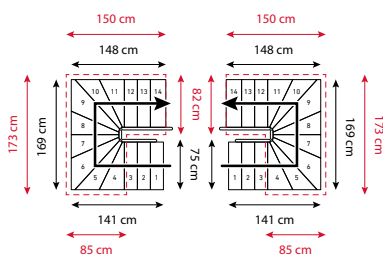
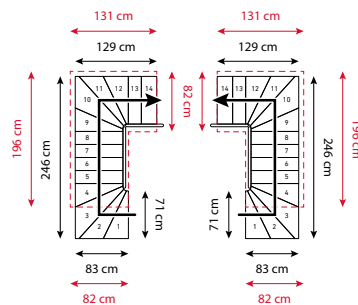
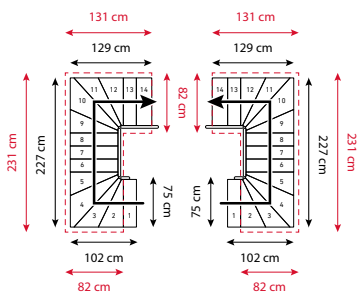
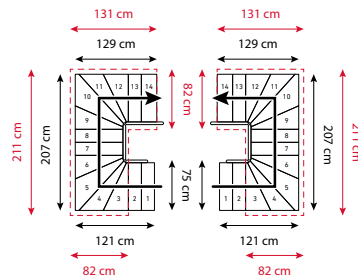
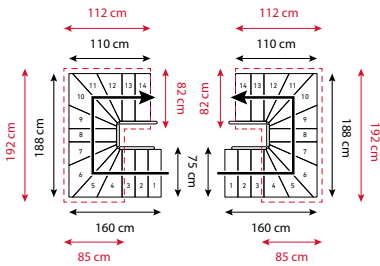
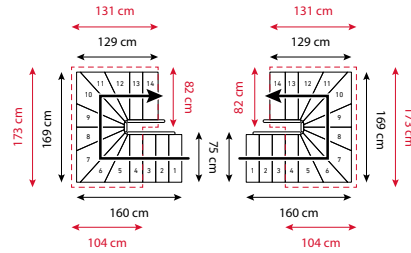
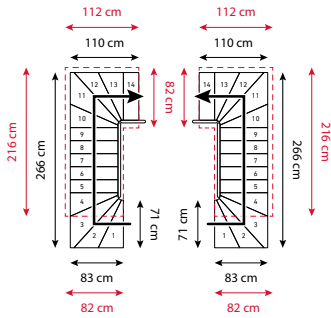

# CORK 14 TREADS

**H** 277.5 - 337.5 cm — Staircase dimensions incl. handrail on 1 side

— Floor opening size is defined based on 2 cm space to wall, 5 cm space for hand, 19 cm rise height, 25 cm deck thickness, 200 cm headspace.

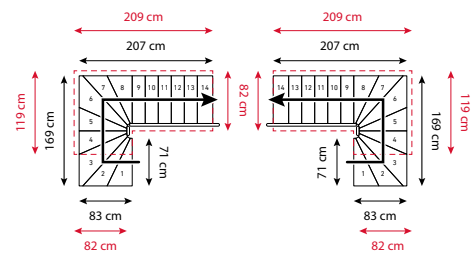
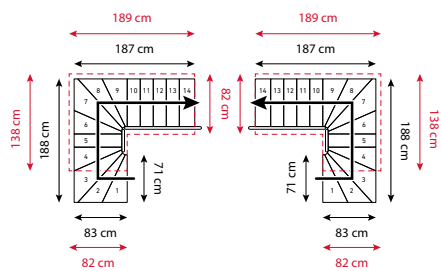
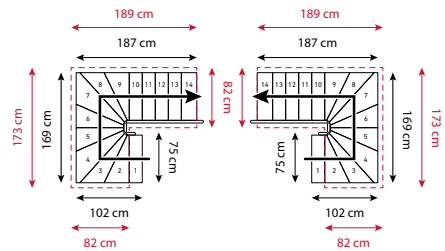
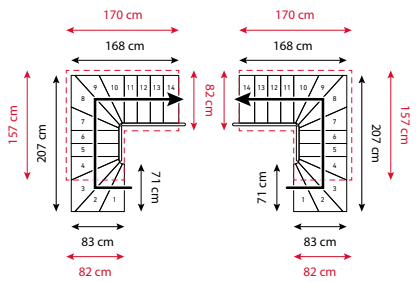
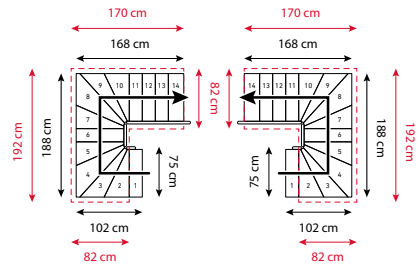
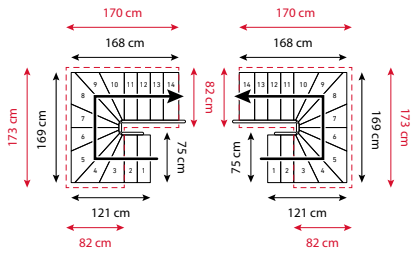
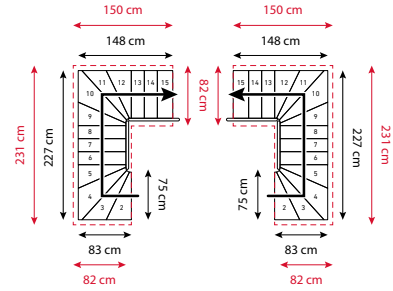
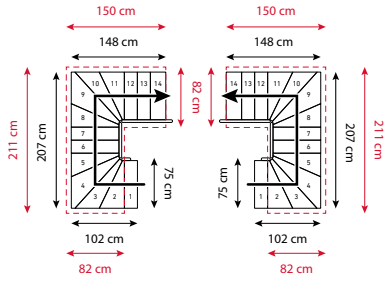

# CORK 15 TREADS

H 296 - 360 cm

— Staircase dimensions incl. handrail on 1 side

- - - Floor opening size is defined based on 2 cm space to wall, 5 cm space for hand, 19 cm rise height, 25 cm deck thickness, 200 cm headspace.

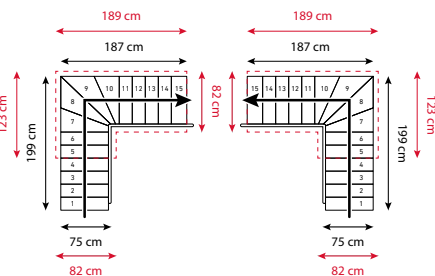
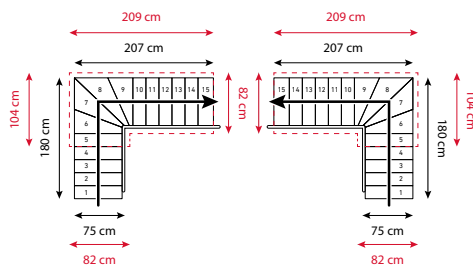
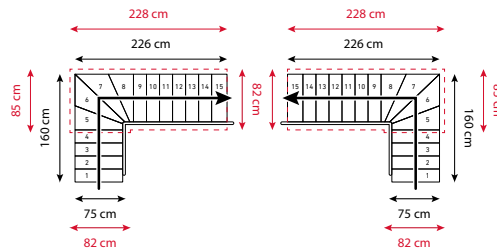
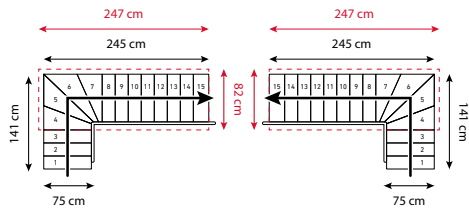
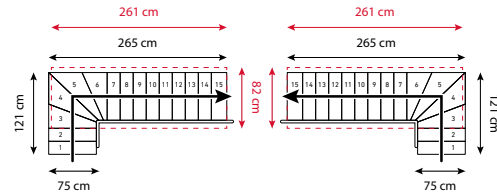
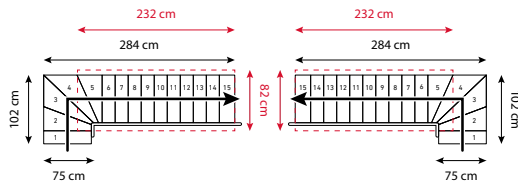
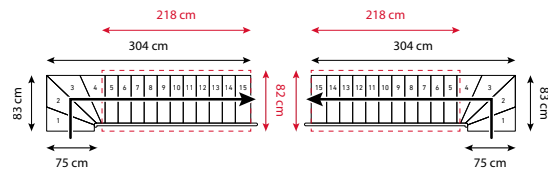
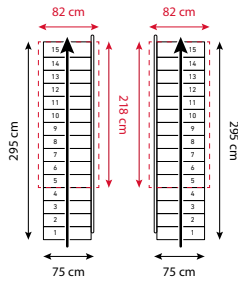

# CORK 15 TREADS

**H** 296 - 360 cm — Staircase dimensions incl. handrail on 1 side

--- Floor opening size is defined based on 2 cm space to wall, 5 cm space for hand, 19 cm rise height, 25 cm deck thickness, 200 cm headspace.

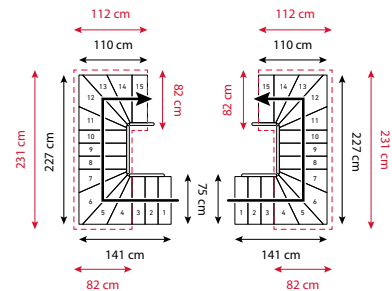
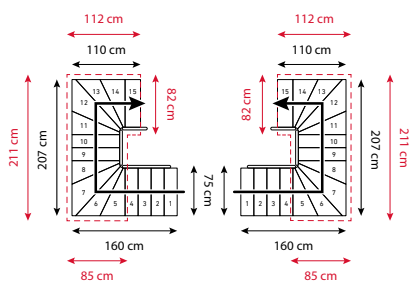
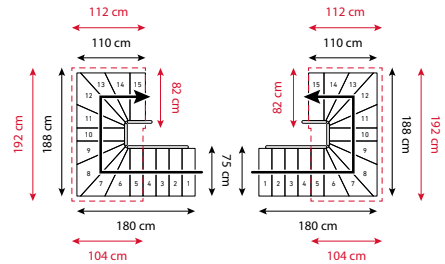
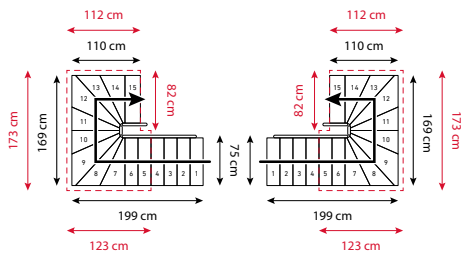
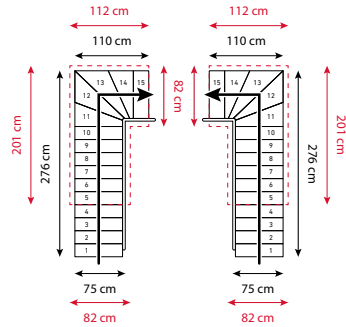
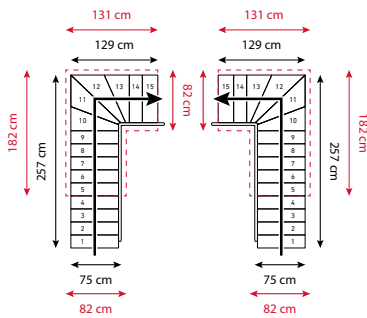
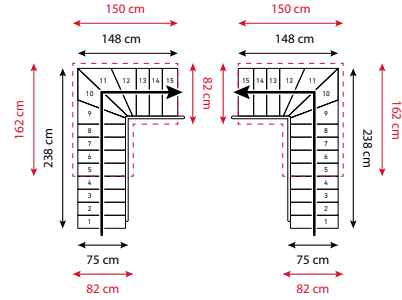
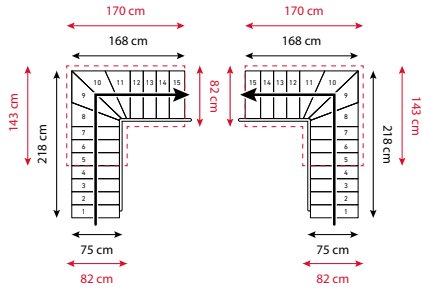

# CORK 15 TREADS

**H** 296 - 360 cm — Staircase dimensions incl. handrail on 1 side

--- Floor opening size is defined based on 2 cm space to wall, 5 cm space for hand, 19 cm rise height, 25 cm deck thickness, 200 cm headspace.

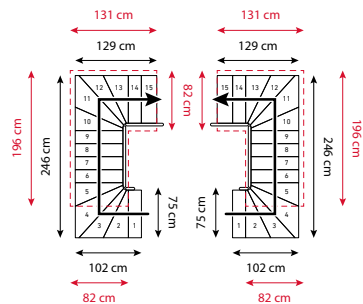
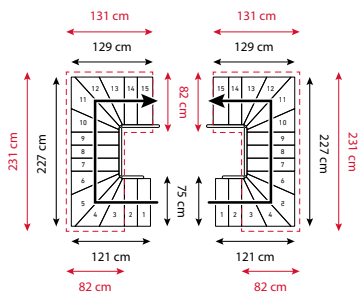
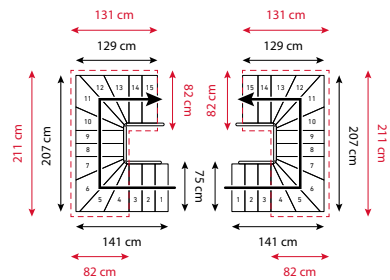
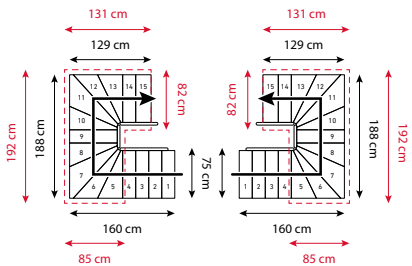
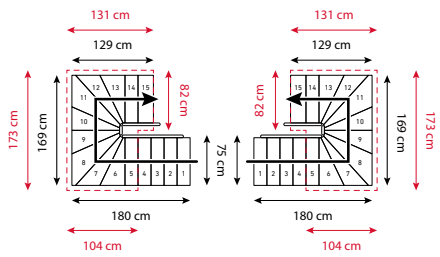
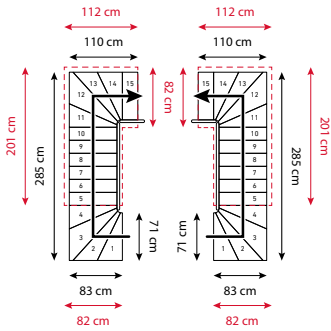
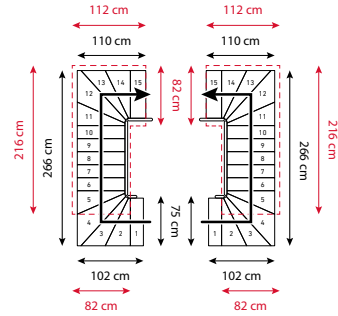
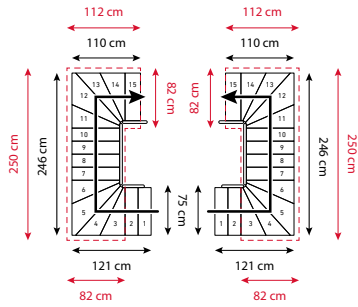

# CORK 15 TREADS

**H** 296 - 360 cm — Staircase dimensions incl. handrail on 1 side

--- Floor opening size is defined based on 2 cm space to wall, 5 cm space for hand, 19 cm rise height, 25 cm deck thickness, 200 cm headspace.

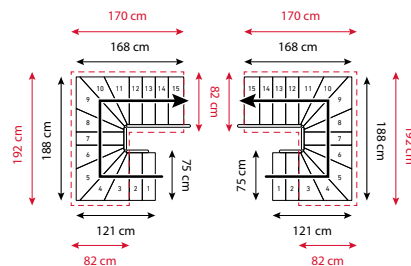
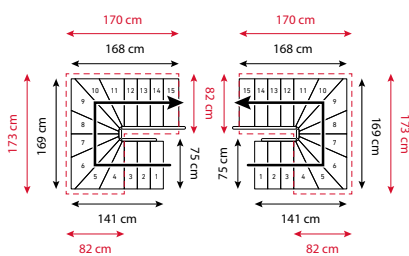
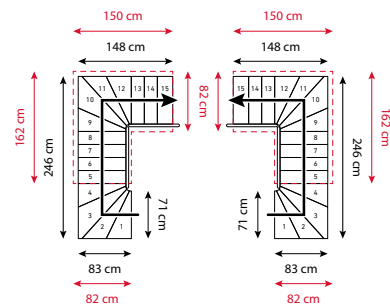
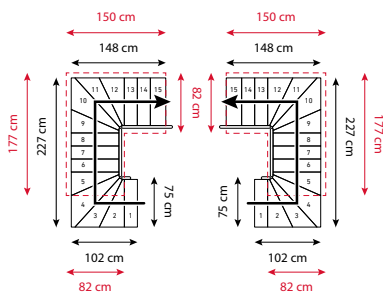
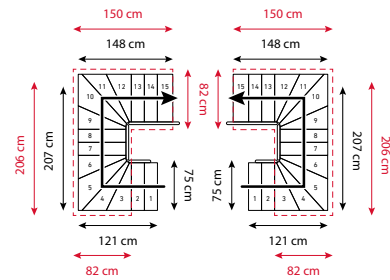
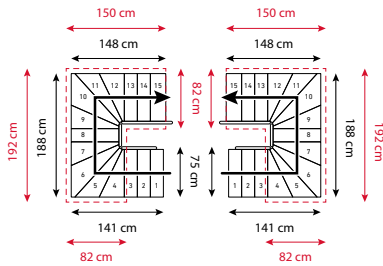
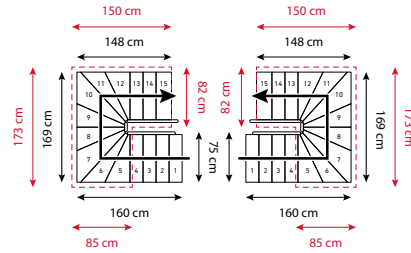
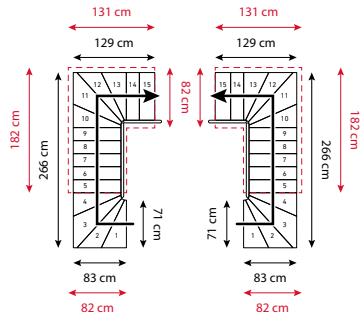

# CORK 15 TREADS

H 296 - 360 cm

— Staircase dimensions incl. handrail on 1 side

- - - Floor opening size is defined based on 2 cm space to wall, 5 cm space for hand, 19 cm rise height, 25 cm deck thickness, 200 cm headspace.

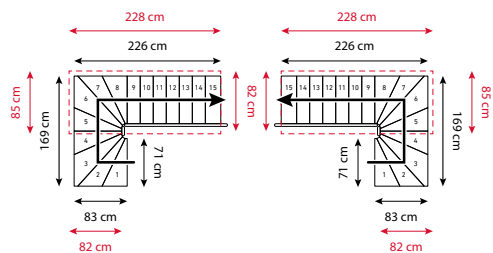
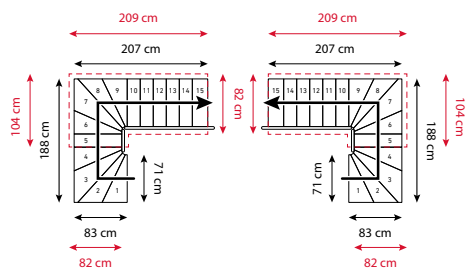
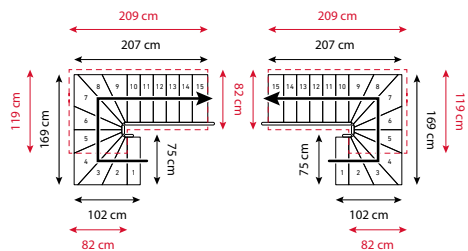
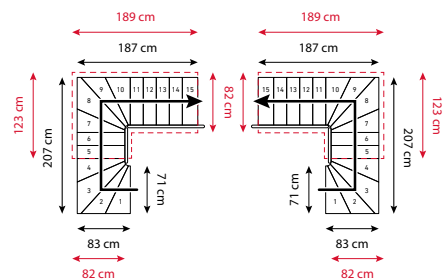
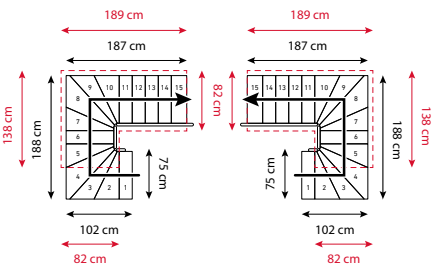
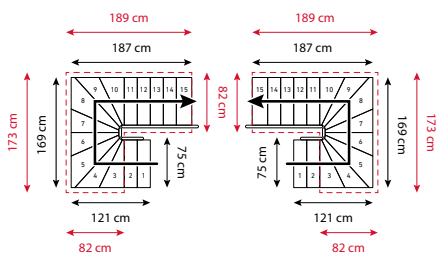
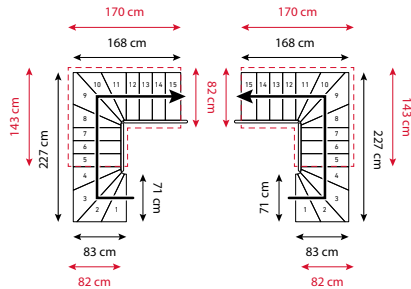
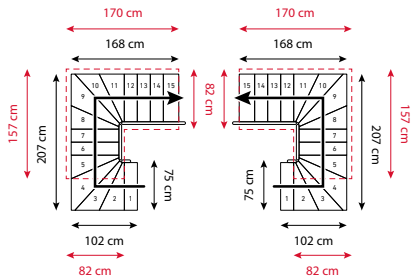

# CORK QUATERTURN

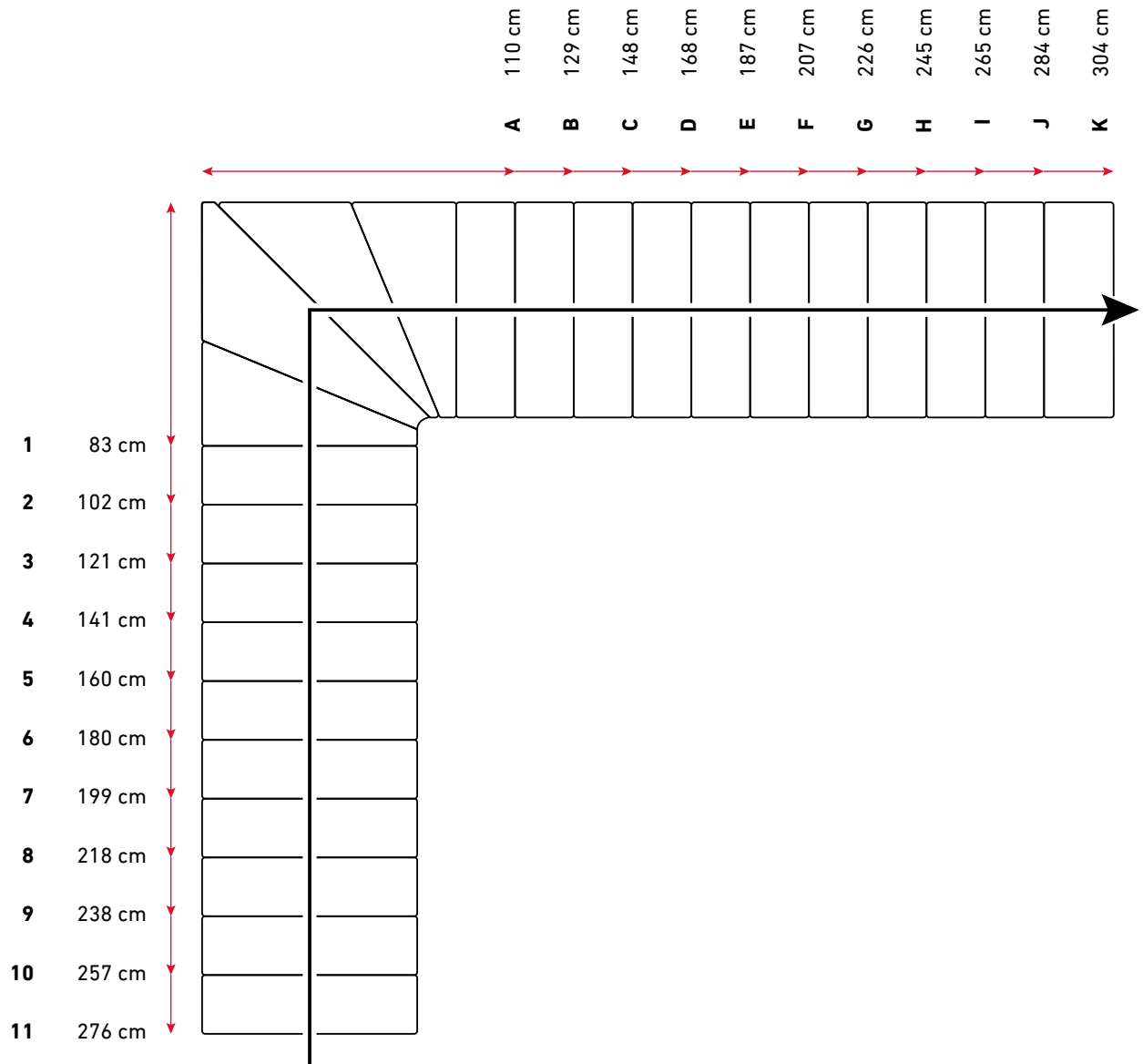



# CORK HALFTURN

